

## Cleaning Your Mask

### AFTER EACH USE:

1. Rinse mouth piece with cold water and let dry out of direct sunlight.

### WEEKLY:

1. Hand wash the Chin Strap and/or Headgear if used, following the same procedure as above.
2. Remove the Pillows from the Mask Frame Assembly and remove the Headgear.
3. Place the Pillows and Mask Frame in lukewarm water that contains a mild soap. Scrub mouthpiece with a soft toothbrush.  
Note: Do not soak for more than 10 minutes.
4. Remove the mask components and rinse them thoroughly in fresh water, ensuring that all soap residue is removed.
5. Leave all parts to dry out of direct sunlight.

### WARNING:

- Do not wash the mask in the dishwasher.
- Do not clean the mask with products that contain chlorine, bleach, moisturizer, antiseptic, anti-bacterial agents or alcohol.
- Do not wash your mask in hot water as this may change the fit of your Mouth Piece.

**Note: Failure to follow the cleaning instructions may compromise the performance and safety of the mask.**

## Disposal

Your mask may be disposed of in the general waste.

## Technical Specifications

### BIAS FLOW DATA

Mask Pressure (cm H <sub>2</sub> O)	4	6	8	10	12	14	16	18	20
Vent Flow Rate (L/min)	19	23	27	30	33	35	38	40	42

### BIAS FLOW GRAPH

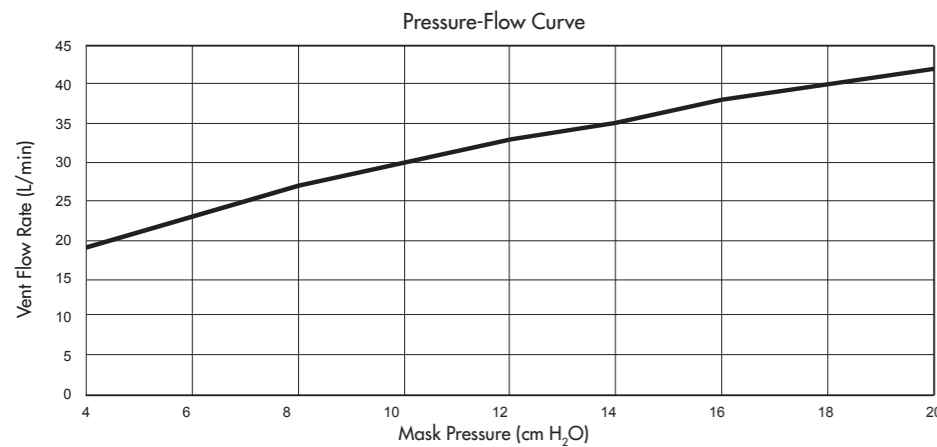

### RESISTANCE TO FLOW DATA

Drop in pressure (through mask at given flow rate)

- At 50 L/min 0.2 cm H<sub>2</sub>O
- At 100 L/min 0.6 cm H<sub>2</sub>O

Drop in pressure with Medium Seal in place

- At 50 L/min 0.6 cm H<sub>2</sub>O
- At 100 L/min 2.1 cm H<sub>2</sub>O

### MASK DEAD SPACE

- 95 mL (the physical dead space is the empty volume of the mask to the end of the swivel)

### SOUND

- The Sound Power Level of the mask is 25.7 dBA with uncertainty 1.96 dBA.
- The Sound Pressure Level of the mask is 17.8 dBA with uncertainty 1.96 dBA.

## Warnings

- US Federal Law restricts this device to sale by, or on order of, a physician.
- This mask should only be used with CPAP/Bi-level equipment recommended by your physician or respiratory therapist. A mask should not be used unless the CPAP/Bi-level device is turned on and operating properly. The vent holes of the mask should never be blocked.  
Explanation of warning: CPAP and Bi-level machines are intended to be used with special masks which have exhalation ports to allow continuous flow of air out of the mask. When the CPAP/Bi-level machine is turned on and functioning properly, new air from the CPAP/Bi-level machine flushes the exhaled air out through the exhalation ports. However, when the CPAP/Bi-level machine is not operating, enough fresh air will not be provided through the mask, and exhaled air may be re-breathed. Re-breathing of exhaled air for longer than several minutes can in some circumstances lead to suffocation.
- If oxygen is used with CPAP/Bi-level machine, the oxygen flow must be turned off when the CPAP/Bi-level machine is not operating.  
Explanation of warning: When the CPAP/Bi-level device is not in operation, and the oxygen flow is left on, oxygen delivered into the ventilator tubing may accumulate within the CPAP/Bi-level machine enclosure. Oxygen accumulated in the CPAP/Bi-level machine enclosure will create a risk of fire.
- Do not use Polyvinyl Chloride (PVC) pressure and/or oxygen tubing. Use silicone tubing instead.  
Explanation of warning: Flexible PVC contains elements that can be detrimental to the materials of the mask, and may lead to cracking or breakage of mask components.
- Do not use if teeth or fillings are loose and seek advice from a dentist if unsure before using this mask.
- Refit the mouth piece if too tight and discontinue use if discomfort persists

- Discontinue use if a reaction is caused by any part of the mask and consult physician
- Discontinue use if experiencing discomfort and consult physician
- Mask is single patient use
- Discontinue use of mask if damaged or cracked and seek replacement
- Do not use mask if vomiting or feeling nauseous
- Do not use mask if patient is unable to remove mask independently
- If bite changes wait to see if the bite returns to normal during the day, discontinue and contact physician if it continues
- Use on adults only (>66lb/30kg)
- Shake loose hot water off mouth piece before placing in mouth
- Do not misuse mask
- In the event of muscle or jaw joint pain, discontinue use for a minimum of two days or until pain subsides and consult physician
- Use a humidifier if experiencing nasal congestion or dry airway
- Combinations with other medical products can alter the performance of the product, e.g. combinations with: humidifier for medical use, nebulizer, heat and moisture exchanger (HME), filters, CPAP, Bi-level positive airway pressure device, self-adjusting sleep apnea breathing therapy device, or additional oxygen supply.
- Electrically conductive breathing tubes should not be used (this warning does not apply to approved heated breathing tubes).
- You must have at least 8 original upper teeth and no removable dentures.
- Do not use if you have any periodontal disease, loose crowns or fillings and broken teeth.
- Do not use if you currently use an orthodontic appliance (ex. Braces)
- You must have seen a dentist in the last 12 months before use.

## Spare Parts

<p>TAP PAP - Nasal Pillow Mask <b>PAPNP1000</b></p>	<p>TAP PAP - Nasal Pillow Mask - No Headgear <b>PAPNP1001</b></p>
<p>TAP PAP -NP- Swivel Connector <b>PAPNP1502</b></p>	<p>TAP PAP - Nasal Pillow Seal Small: <b>PAPNP1101</b> Medium: <b>PAPNP1102</b> Large: <b>PAPNP1103</b></p>
<p>TAP PAP - Upper Mouth Piece <b>PAPNP1201</b></p>	<p>TAP PAP - Nasal Pillow - Headgear <b>PAPNP1300</b></p>
<p>TAP PAP Chin Strap <b>PAP000400</b></p>	<p>TAP PAP - Nasal Pillow - Nut and Bolt <b>PAPNP1500</b></p>

This product is protected by US and foreign patents.

For a list of patents related to this product please go to <http://amisleep.com/patents/>

**Airway Management**  
3418 Midcourt Road, Suite 114, Carrollton, TX, 75006, USA  
(866) 264-7667  
[www.amisleep.com](http://www.amisleep.com)



100200101 Rev. D

To visit our website with your smartphone, open your QR code Reader App and scan:



[www.MyTAPPAP.com](http://www.MyTAPPAP.com)

# TAP<sup>®</sup> PAP Nasal Pillow Mask

## Patient Instructions for Use

866-414-9700

[www.TheCPAPShop.com](http://www.TheCPAPShop.com)



AIRWAY MANAGEMENT | 3418 Midcourt Road | Suite 114 | Carrollton, TX 75006, USA

[Facebook.com/MyTAPPAP](https://www.facebook.com/MyTAPPAP)

866.264.7667 | MYTAPPAP.COM

## Intended Use

The TAP PAP Nasal Pillow Mask is intended to be used by individuals who have been diagnosed by a Physician as requiring CPAP or Bi-level ventilator treatment. The TAP PAP Nasal Pillow Mask is intended for single patient adult (>66 lb./30 kg) use in the home, hospital or other clinical setting.

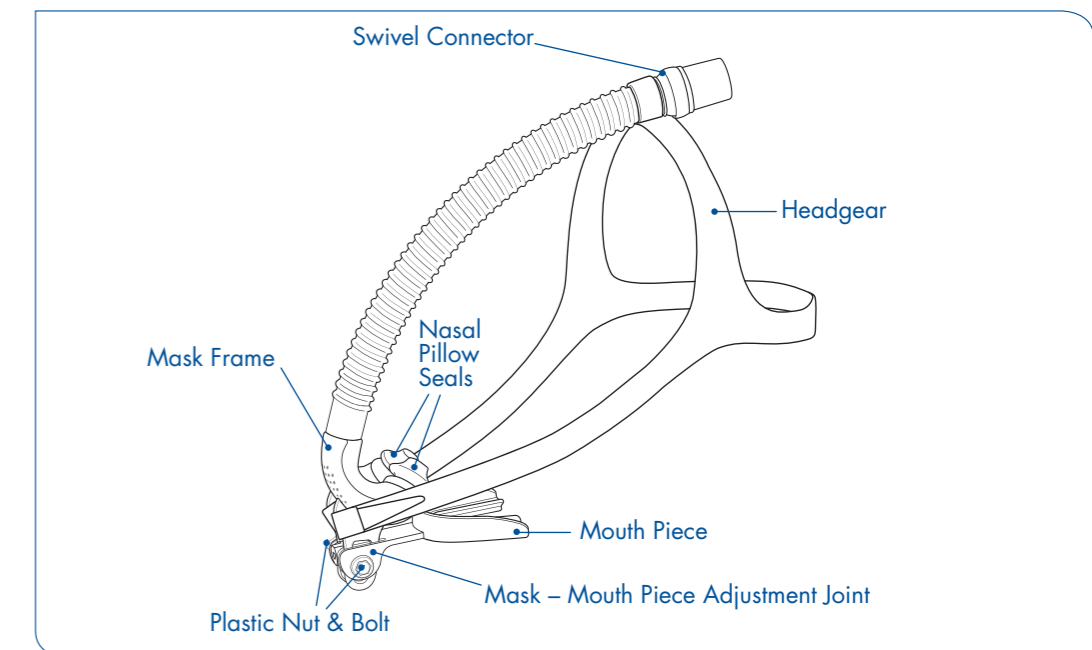

## Operating Instructions

The operating pressure range of the mask is 4 to 20 cm H<sub>2</sub>O.  
The transport and storage temperature range of the mask is -20 to 50 °C (-4 to 122 °F)  
The operating temperature range of the mask is 5 to 40 °C (40 to 104 °F)

### BEFORE EACH USE:

- Make sure the air path through the mask is clear.
- Inspect the vent holes. Do not use if blocked.
- Inspect the mask for damage. Do not use if there is any visible deterioration (tears, cracks etc), and seek replacement part(s).

**Note: Failure to follow the operating instructions may compromise the performance and safety of the mask.**

## Fitting Your Mask

### Warning

You must have at least 8 original upper teeth and no removable dentures.  
Do not use if you have any periodontal disease, loose crowns or fillings and broken teeth.  
Do not use if you currently use an orthodontic appliance. (Ex. Braces)  
You must have seen a dentist in the last 12 months before use.

### FITTING YOUR MOUTH PIECE

The first step to fitting your mask is to fit your mouth piece. It is the most important part of fitting your mask, and once done correctly will enable you to easily fit the rest of your mask.

Before starting this process ensure that you do not have any loose teeth or fillings, as the mouth piece of this mask may dislodge loose teeth, fillings or dental work. If you are unsure, stop and seek advice about the suitability of this mask for you from a dentist before use.

This process can be repeated using the same mouth piece to adjust the fit as necessary.

**Please read these instructions in full before starting to fit your Mouth Piece**

1. Loosen the nut, remove the ThermAcryl Mouthpiece and set the nut & bolt aside
2. Place the mouthpiece over your upper teeth, bite gently to check that your teeth fit within the flat surface of the tray. If not, you will need to narrow or widen later in the fitting process.
3. Pour boiled water into a bowl. Then submerge the mouthpiece in the water for 1 minute. Remove the mouthpiece with a pair of tongs and shake off the excess water. Finally, set the mouthpiece on the counter top for 20 seconds.
4. If you determined in step 2 that the tray needed to be widened or narrowed, please do so now and recheck the sizing before going to step 5.
5. Place the mouthpiece over the upper teeth. Be sure that the clear post is directly aligned with your nose. You can do this by looking in a mirror or cupping your hands over your nose and mouthpiece.
6. For 2 minutes, suck on the mouthpiece while pushing up against the back of your teeth to seat the mouthpiece.
7. For 2 minutes, open your mouth and breathe normally with the mouthpiece in place.
8. Place your fingers on the top edge of the mouthpiece on both sides of the tray along your molars. Pull downward to remove the mouthpiece.
9. You are finished fitting the mouthpiece. Lay it aside with the nut and bolt. It is now time to fit the mask.

### Helpful Fitting Tips

If it is tight, when cold use your thumbs to spread (widen) the mouthpiece  
Your mouthpiece should fit snug and be comfortable to work properly  
If it is too tight, place it under hot tap water for 15 seconds and reinsert  
Practice putting it on and off your teeth repeatedly  
If you have never worn a mouthpiece, it may take a few days to get used to it  
If it is too loose, repeat the fitting process using boiled water

### FITTING YOUR NASAL PILLOW MASK

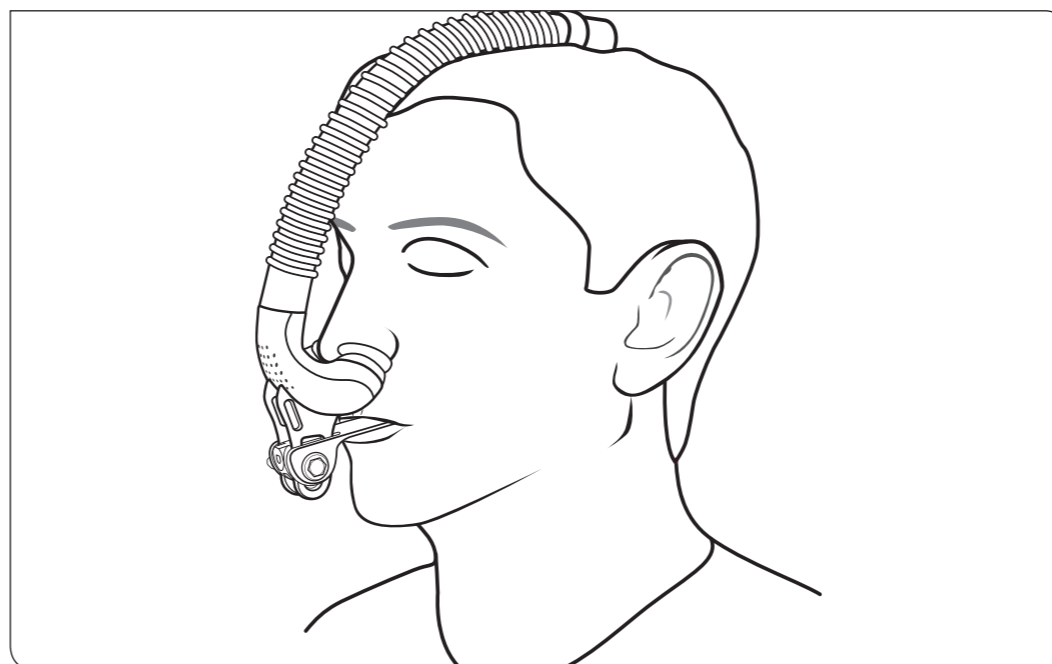

1. The TAP PAP Nasal Pillow Mask comes with three sizes of Pillow. Hold the Mask Frame with the Medium size Pillow against your nostrils to check for sizing. You should use largest size Pillow that you can, ensuring that the Pillow outlets fit comfortably into your nostrils. If you are unsure you can try the different sizes after you have completed the fitting process and have connected your mask to your CPAP machine.
2. Assemble the Mask Frame with the Mouth Piece.
3. Place the Bolt through the Adjustment Joint (as shown) and loosely screw on the Plastic Nut.

Note: this can be assembled with the Plastic Nut on the left or right side.

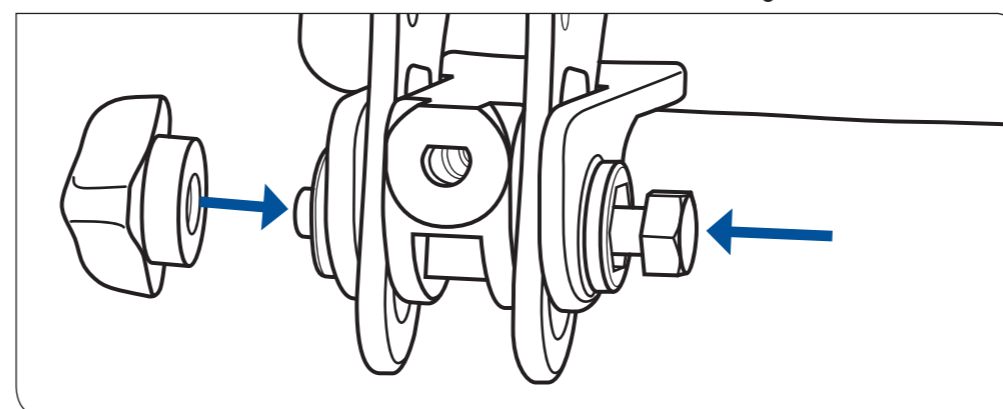

4. Place the Mouth Piece on your upper teeth.
5. Adjust the Mask Frame so the Pillows rest gently against your nostrils. The Mask Frame can move up and down, closer and further away from your nose and the angle can be changed.

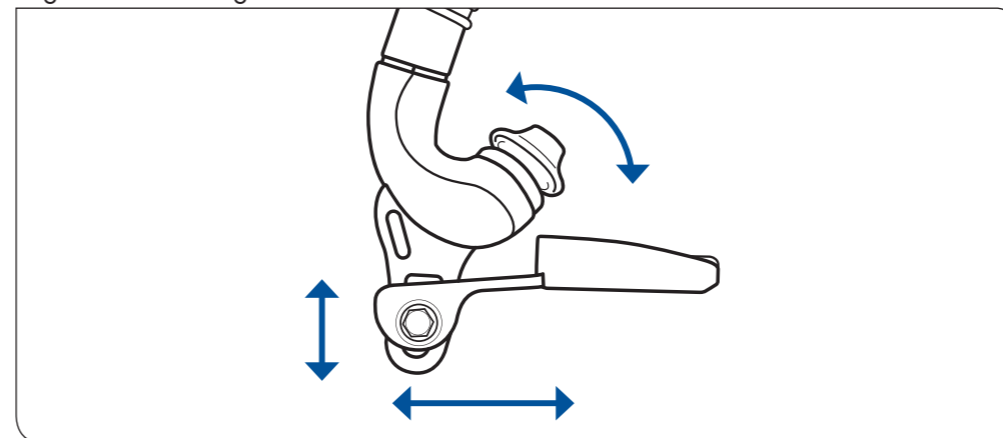

6. Holding the mask in place with one hand, firmly tighten the Plastic Nut to lock the Mask Frame in place.

### CHANGING AND ADJUSTING YOUR PILLOWS

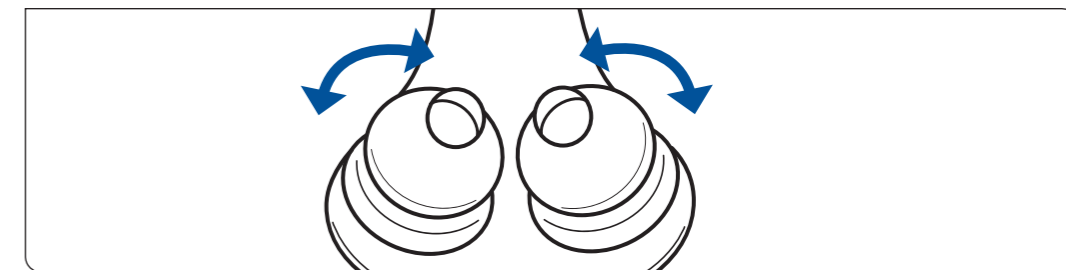

1. The angle of each Pillow may be adjusted individually to suit the angle of your nostrils. To do this, grab the Pillow at its base and rotate.
2. To assemble a Pillow into the Mask Frame Assembly,
  - a. Gently squeeze the Pillow with your thumb and middle finger.
  - b. Guide the lower part of the Pillow into place.
  - c. Use your forefinger to push the upper part of the Pillow into place.
  - d. Then push down firmly against the base of the Pillow to secure it.
3. You may find it beneficial to use a different size of Pillow for each nostril.

### TESTING THE FIT OF YOUR MASK

Connect your mask to your CPAP machine, turn the machine on and test the fit of your mask.

- If your mask leaks air against your face you can adjust the angle and position of the Mask Frame by loosening the Plastic Nut while wearing the mask to find a better position.
- You may also need to try a different size Pillow.
- If your mask is not centrally located below your nose it may not seal as well as it should. In this case you should refit your Mouth Piece, to adjust the Mask – Mouth Piece Adjustment Joint to a central position.

### TAP PAP CHIN STRAP

If you experience a significant amount of air leaking out of your mouth, or you get a dry mouth, you may find it beneficial to use an Airway Management Chin Strap.

This will help hold your mouth closed while you sleep and is available as an optional accessory. You may also need to turn your humidifier up.

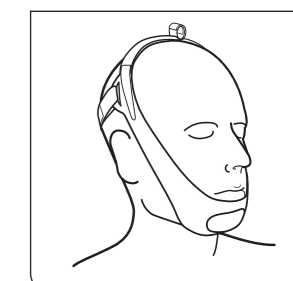

### Condensation or Whistling

If you experience whistling sounds or excessive condensation in your mask, you may need to turn down your humidifier. Do this gradually, over a few nights, to avoid reducing the humidity too much.

### Using Your Headgear

You may find it beneficial to use TAP PAP headgear to help hold your mask in place and hold the Tube in position on top of your head. The headgear connects to the Mask Frame in slots that are located above the Adjustment Joint. The Tube Anchor can be used to hold the Tube in place.

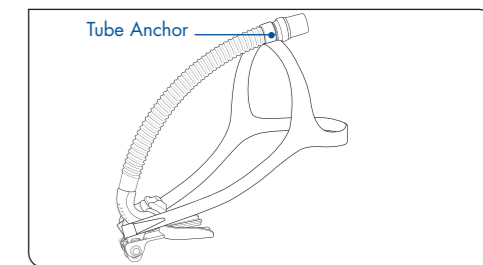
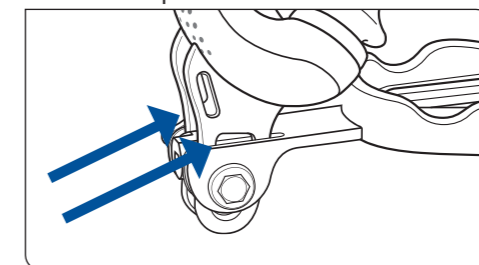

### Using Your Swivel Connector

Your TAP PAP Nasal Pillow Mask may be disconnected from the main CPAP Tube by disassembling the Swivel Connector. It is easiest to assemble and disassemble the Swivel Connector at an angle.